



## HYUNDAI i30N FMSS3 FITTING INSTRUCTIONS



Please thoroughly read through and familiarise yourself with these instructions in their entirety prior to beginning any part of the installation process of any component. Please also ensure the vehicle and engine has cooled down sufficiently to avoid risking possible skin burns or other injury.

### **TOOLS NEEDED:**

10/13/14mm socket with extension

Flat bladed screwdriver

1. First step is to remove the battery from the vehicle, to do this undo the 10mm nuts of the battery terminals use a 10mm spanner or socket. **REMOVE THE NEGATIVE FIRST.** Next remove the 13mm fastener that holds the battery clamp in place, use a 13mm socket and ratchet with extension then remove the clamp from the vehicle. The battery will now lift out of the engine bay.

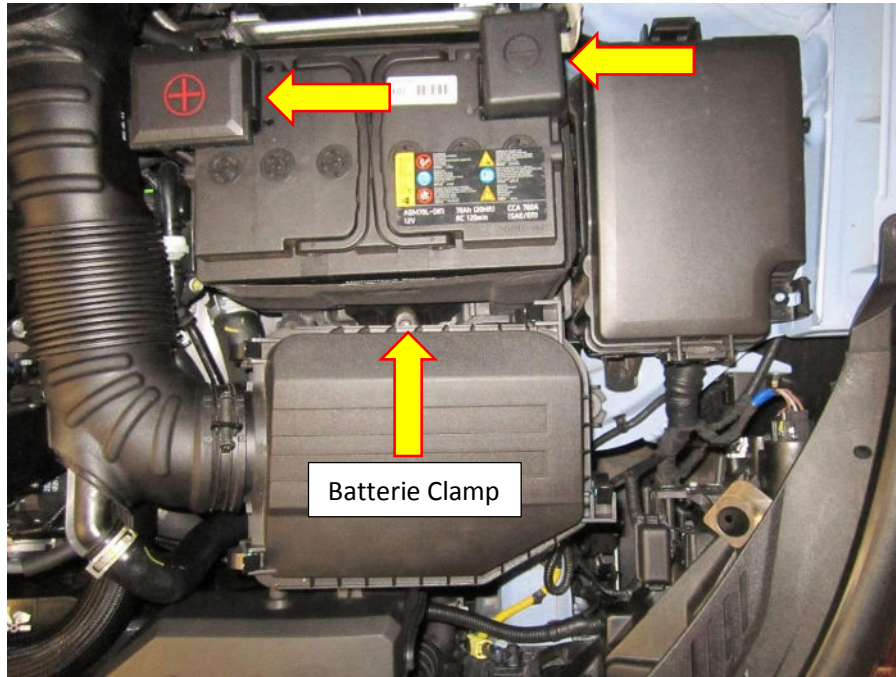

2. With the battery now removed from the car the next step is to remove the vehicles ECU. Unplug the two connectors at the top of the ECU.

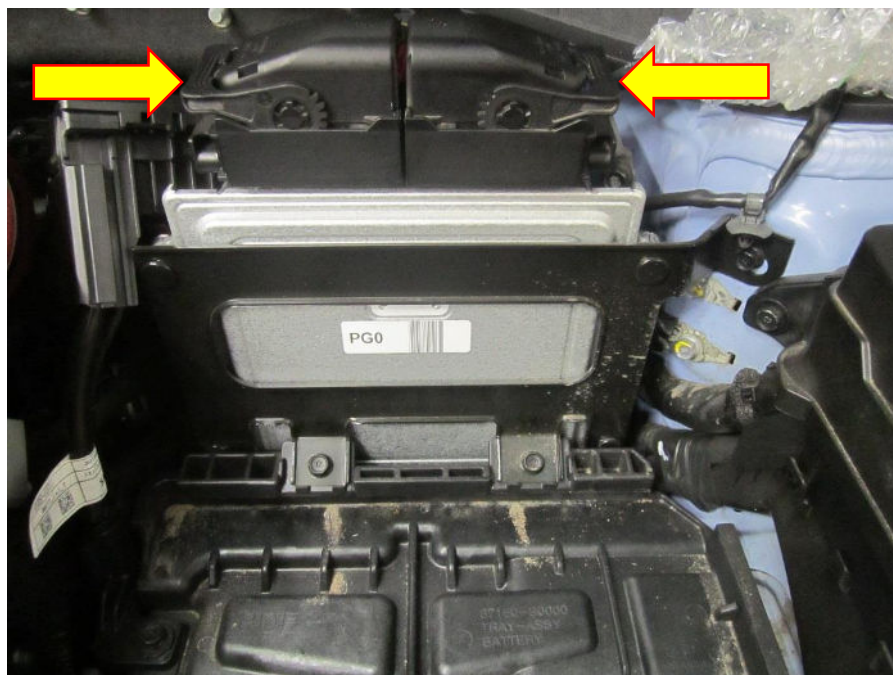

3. Once unplugged you can now remove the three 10mm fasteners that hold the ECU in position, two at the bottom and one at the top right. Use some long nose pliers to remove the plastic fastener that is holding the negative battery cable to the ECU bracket.

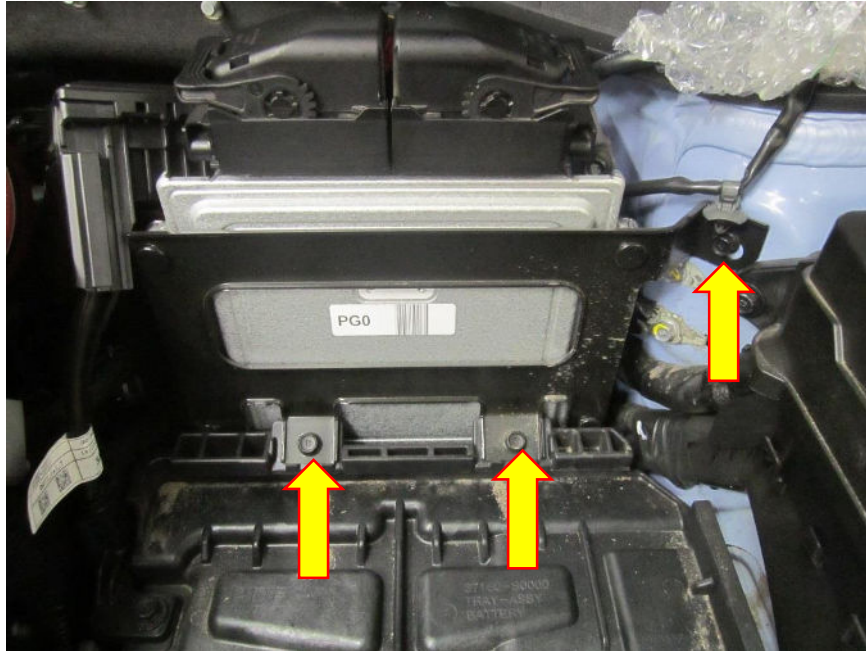

4. The battery tray is the next component that needs to be removed, to do this remove the three 12mm fasteners holding the battery tray to the chassis, use a 12mm socket with extension bar to do this. There is also a wiring harness attached to the battery tray which is held in place with two 10mm fasteners, remove both fasteners with a 10mm socket and ratchet to release the wiring loom. Now lift the tray from the engine bay.

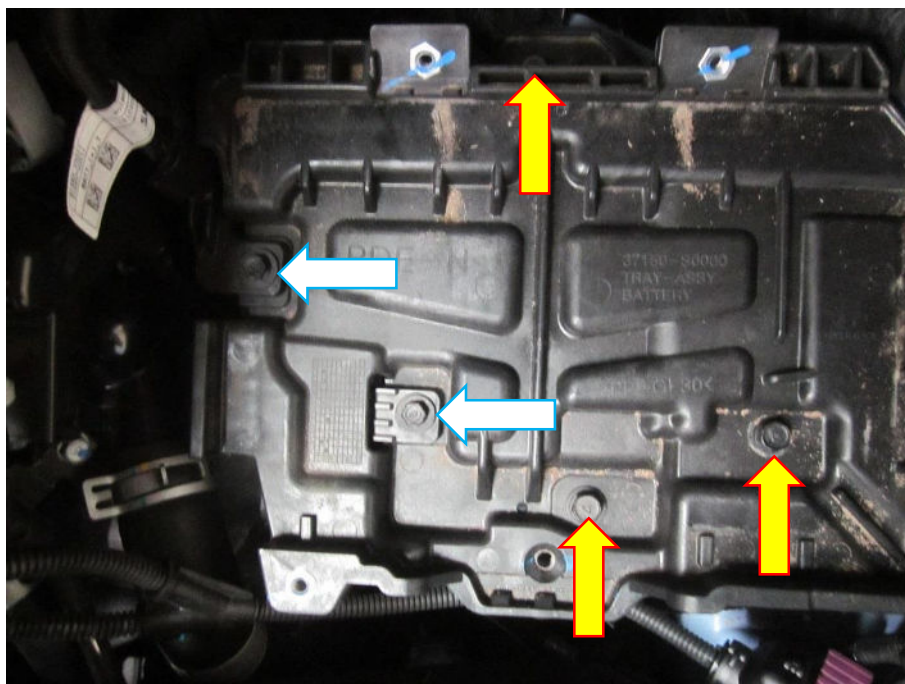

5. With the battery tray removed you will be able to see the gear shifter cables which are attached to the gearbox linkage. Both cables are attached with an R clip, to remove the R clip simply lever them open with a flat blade screw driver and pull them out. You will now be able to free the cables from the gear linkage.

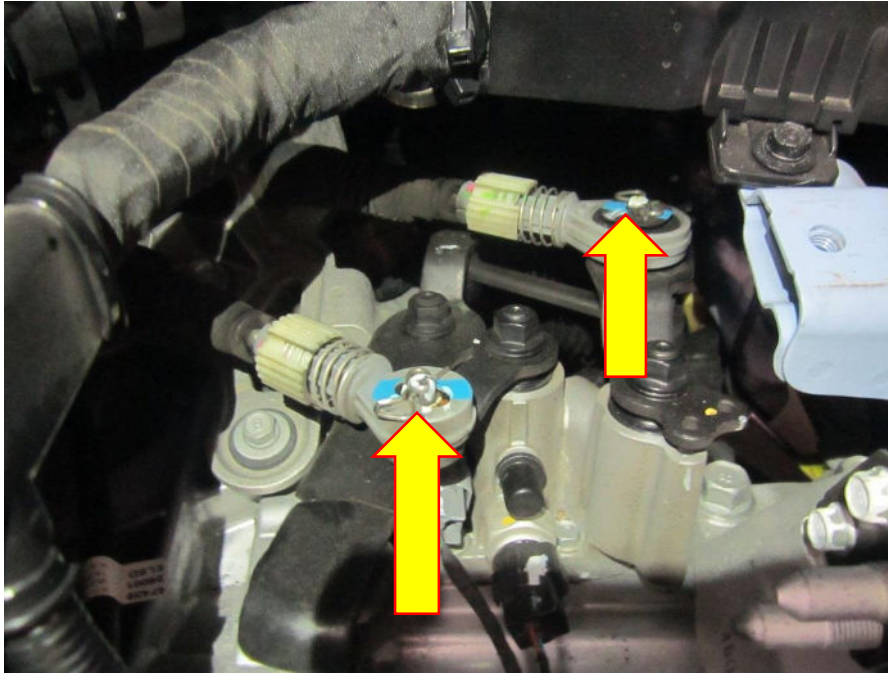

6. There are three 14mm fasteners that hold the linkage to the gearbox. Remove these with a 14mm socket and ratchet, with these removed the linkage will lift off with gentle persuasion.

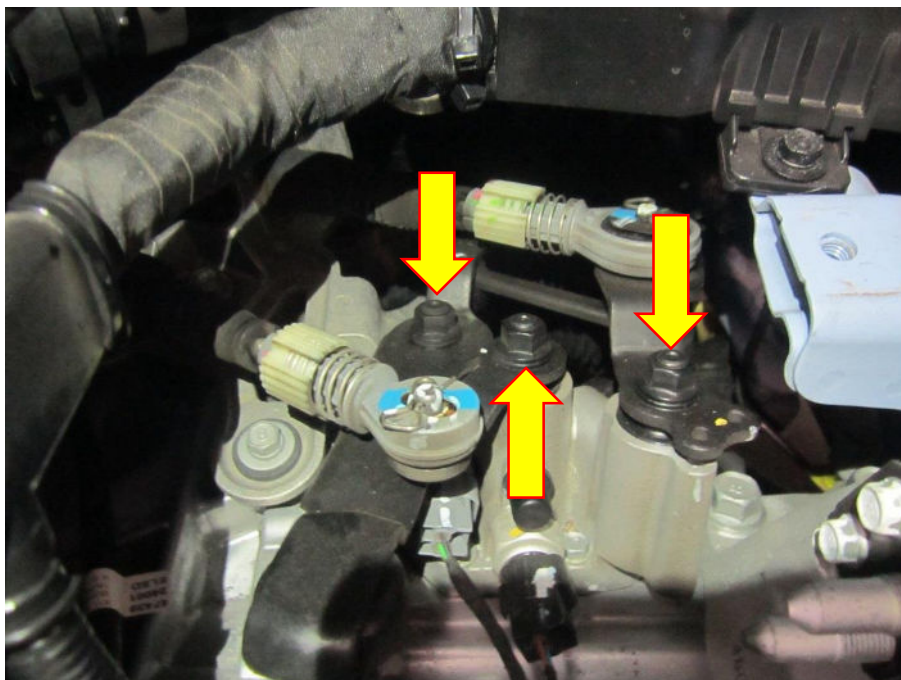

7. With the OE gear linkage removed from the vehicle you will now be able to split the back and forth part of the linkage. Remove the rubber dust cover shown in the picture, with that removed you will see a circlip holding the linkage together. With the use of a flat blade screw driver prise the circlip out of its mounting, this will then allow you to remove the back and forth part of the linkage

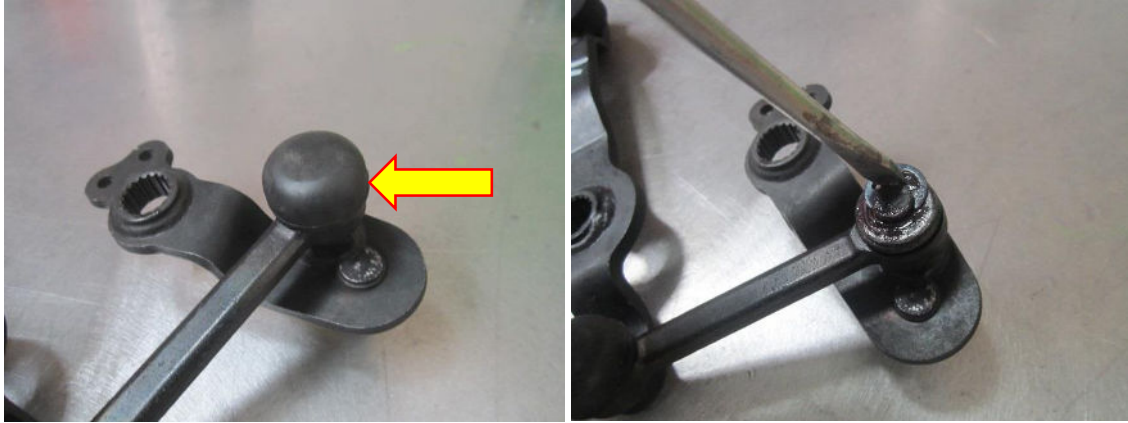

8. At this point you will need to set up your new Forge Motorsport short shift linkage. Assemble the link as shown in the diagram below using a 13mm spanner or socket and ratchet to tighten the cable pins in place, the pins have two flat edges to locate it securely in the slot. These pins are the adjustment for the shift length, to make the shift shorter move the pin closer to the toothed location hole.

**Please Note:**

**We suggest half of the slot to three quarters towards the splined hole of the short shifter is the optimum position. In some cases, full adjustment to the shortest position may not be possible due to the factory cable length which can differ from car to car.**

Please note that the pins are different lengths. The larger pin is used on the S shaped linkage and the shorter pin on the flat linkage.

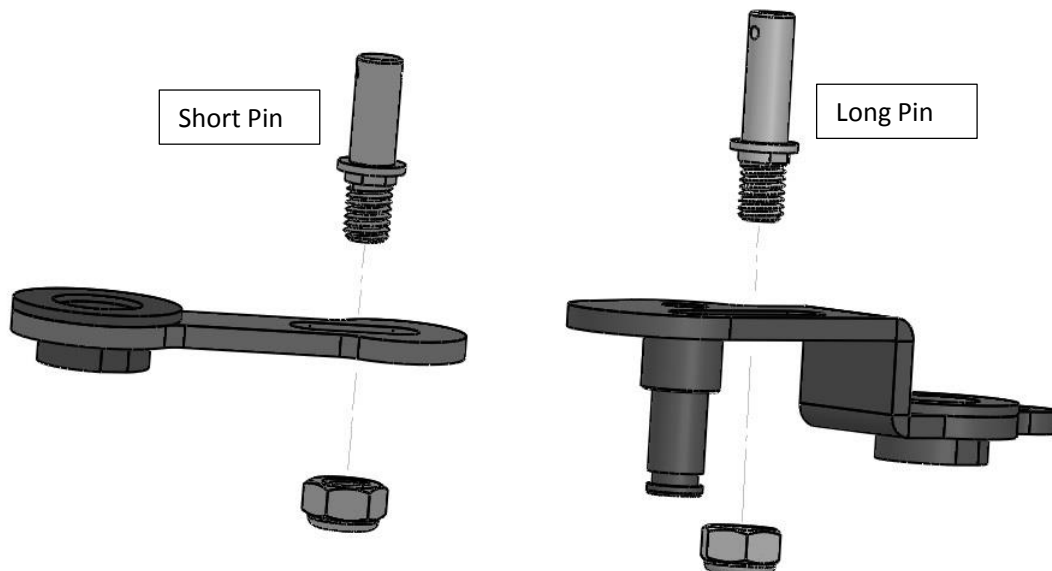

9. You can now fit the Forge back and forth linkage to the OE part as illustrated below, this is the reverse of step 7.

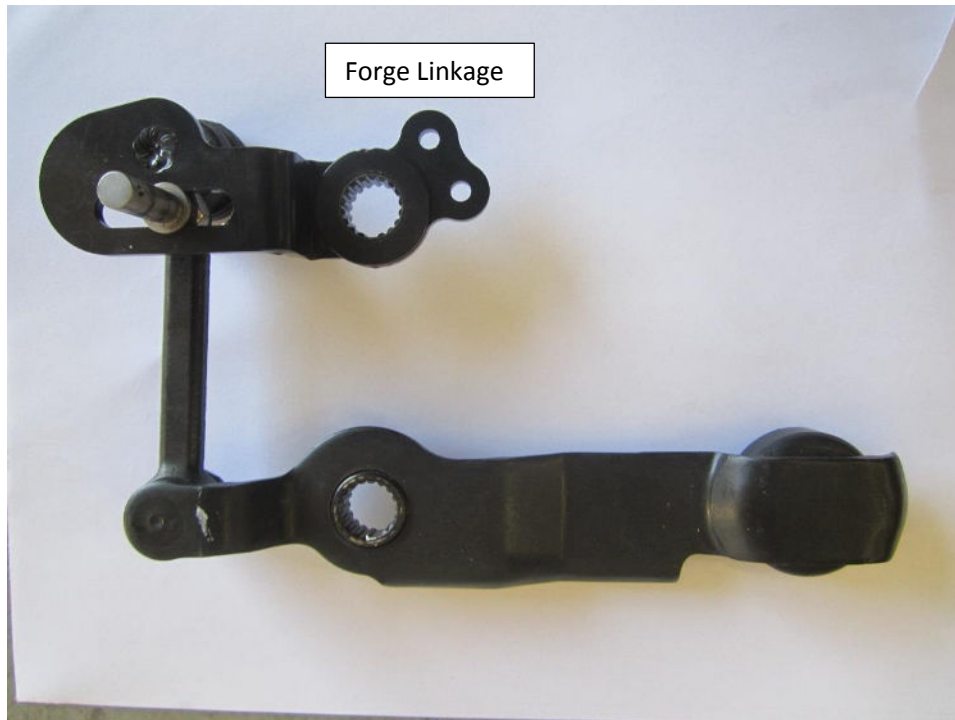

10. You are now able to fit the Forge linkage to the gearbox, fit the dual linkage first leaving the small single linkage to last. This bit is a bit fiddly to do but with patience it will fit perfectly. DO NOT FORCE THE LINKAGE ON TO THE GEAR BOX. The toothed splines are keyed and will only fit on in one orientation. **ON SOME VEHICLES YOU MAY NEED TO ADJUST THE GEAR CABLE ENDS, SIMPLY SLIDE COLLAR FORWARD AND PUSH THE PINK CLIP OUTWARD AND THEN ADJUST THE CABLE END TO THE DESIRED LENGTH. PUSH THE PINK CLIP DOWN TO LOCK THE CABLE END IN TO THE NEW POSITION.**

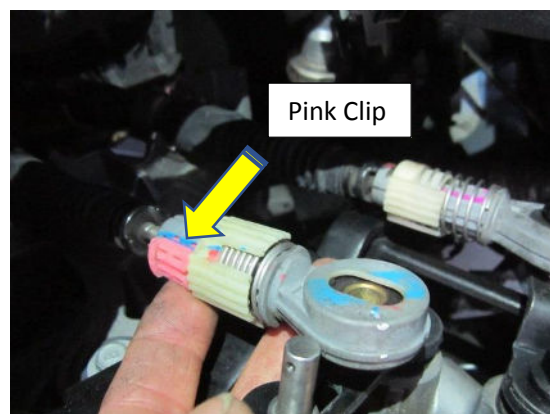
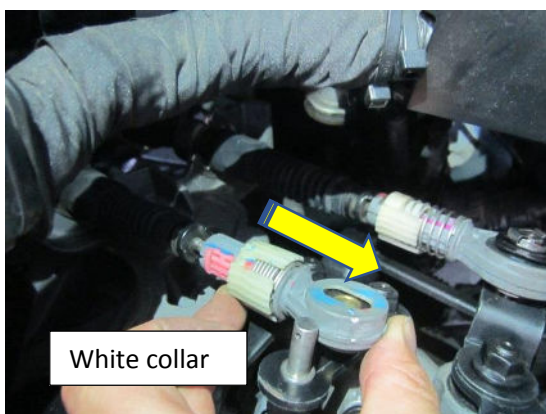

11. Tighten the three fasteners that hold the linkage to the gearbox, then test to see how the shift feels inside the car. If you think it needs adjustment this is the time to do so, now reassemble by following the steps 1-6 in reverse.

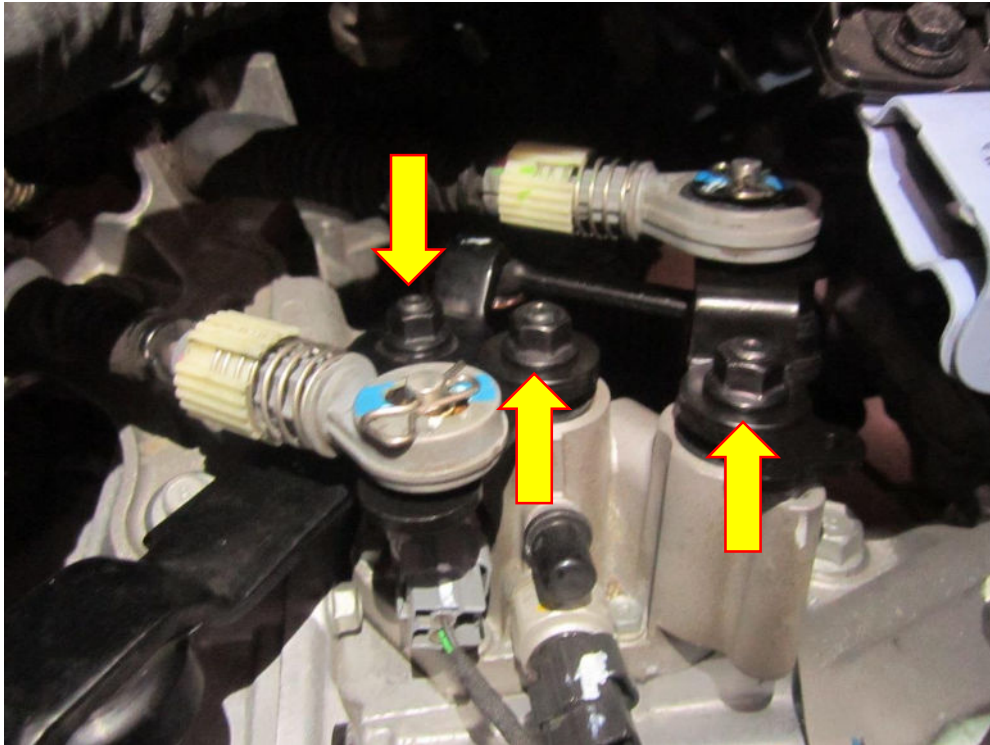

12. The following process may be required to avoid any issues caused by disconnecting the battery and ECU.  
Once the vehicle is all back together, lock the car and leave it for two minutes then unlock it.
13. Start the engine and take the vehicle for a test drive. Your installation is now complete.